



From a market of dreamers to economical shocks

Houman Owhadi

LATP, UMR CNRS 6632, CMI, Université de Provence, France

Received 21 April 2004

Available online 22 June 2004

Abstract

Over the past years an intense work has been undertaken to understand the origin of the crashes and bubbles of financial markets. The explanations of these crashes have been grounded on the hypothesis of behavioral and social correlations between the agents in interacting particle models or on a feedback of the stock prices on trading behaviors in mean-field models (here bubbles and crashes are seen as collective hysteria). In this paper, we will introduce a market model as a particle system with no other interaction between the agents than the fact that to be able to sell, somebody must be willing to buy and no feedback of the price on their trading behavior. We will show that this model crashes in finite estimable time. Although the age of the market does not appear in the price dynamic the population of traders taken as a whole system is maturing towards collapse. The wealth distribution among the agents follows the second law of thermodynamics and with probability one an agent (or a minority of agents) will accumulate a large portion of the total wealth, at some point this disproportion in the wealth distribution becomes unbearable for the market leading to its collapse. We believe that the origin of the collapse in our model could be of some relevance in understanding long-term economic cycles such as the Kondratiev cycle.

© 2004 Elsevier B.V. All rights reserved.

PACS: primary 74Q20; 60J60; secondary 35B27; 74Q10; 60F05; 31C05; 35B05

Keywords: Quantitative finance; Wealth distribution; Market crash

1. Introduction

Financial markets are characterized by the randomness of the price fluctuations, cycles and crashes [1]. Over the past years two categories of models have been developed to explain the collapse and the depression cycle generated by these markets. The first

E-mail address: owhadi@cmi.univ-mrs.fr (H. Owhadi).

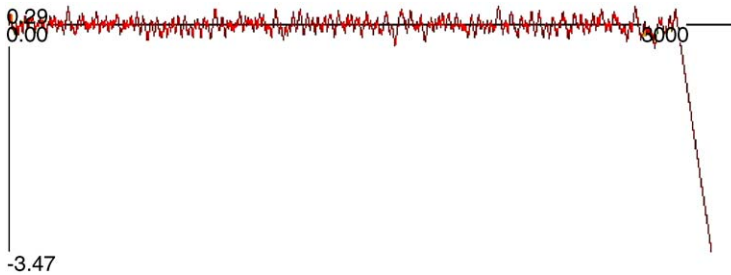

Fig. 1. Simulation with $2N = 1000$.

kind of model is a mean-field model [2] where the price is seen as a stochastic differential equation (a Langevin equation) encapsulating the feedback of the price fluctuations on the behavior of the market participants. The second kind of model is a particle or agent-based model [3–5] where agents have different strategies and are reacting to the price fluctuations and the behavior of the other agents. These behavioral interactions and price dynamic feedbacks are the key ingredients in these models for grounding the explanation of a market collapse and depressive cycle.

Our purpose in this paper is to show that these price fluctuations feedback or the behavioral interactions are not necessary to obtain a collapse of the market and even without them the propagation of chaos in the wealth distribution of the market participants is sufficient to generate a market crash. We will introduce an agent-based market model in Section 2 with no price feedback and no other interaction between the agents than the fact to be able to sell somebody must be willing to buy. This simple model leads to a market crash in a finite time (see Fig. 1). We will investigate the existence of a precursor before the crash and show that although it is not obvious to find one in the price dynamic there exists one (in our model) not linked to the price.

The explanation of the crash is to be found in the dynamic of the wealth distribution of the agents. Assume that all the traders start with the same initial wealth, their individual decisions lead to the propagation of chaos in that distribution (corresponding to the second law of thermodynamics), this randomness is sufficient to lead to the accumulation of a large amount of total wealth of the market by a few traders, this diffusion having no limit at some point it becomes unbearable for the market leading to its collapse. We believe that wealth accumulation as a mechanism for a market crash is not specific to our (oversimplified) model. Indeed Financial markets are mixing environments for the wealth of the agents (since the gains and losses of the traders are random) leading to the diffusion of wealth among the traders and a market crash is an extreme transfer and concentration of wealth.

In his basic form our model crashes as soon as one trader holds more than half of the total wealth of the market and of course this is unrealistic. However, if one assumes that as soon as a trader reaches a fixed non-negligible amount of the total wealth (say 5%) he removes his capital from the market and invest it in an other form (say in real state) then one obtains Fig. 2 showing the logarithm of the stock price against time. In that figure the richest trader start to sell his stocks around time 10 000

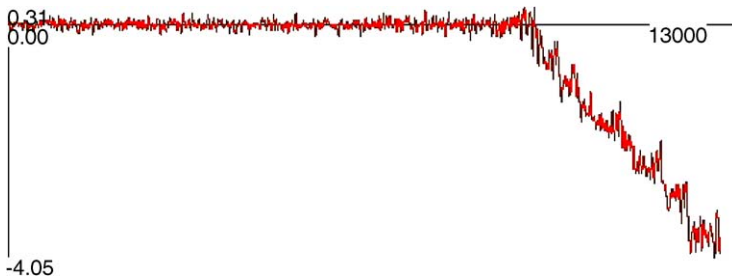

Fig. 2. A crash generated by our model.

leading to first bearish wave, if he was the only one to sell, the price would reach another equilibrium price below the initial one but soon afterwards a second trader having accumulated a large amount of the total wealth start to sell his stocks leading to a second bearish wave and so on. This leads to a dynamic of the logarithm of the stock price characterized by oscillations around a negative trend (it is interesting to relate this to log-periodic oscillations observed in market crashes, we refer to [1] for a survey).

2. The model

Our model is composed of $2N$ traders ($N \in \mathbb{N}$, $N \geq 2$). The traders have the choice between holding their wealth in a position called Stock (stock of a single firm for instance in this model) or in a position called Liquid (dollar for instance), the choice being exclusive (all their wealth is on Stock or Liquid not a portion on Stock and its complementary on Liquid). We write $p(t)$ the logarithm of the price of an unit of stock at time t . Each agent is characterized by clock independent from the price and the other agents and has a probability μdt to return his position during the time dt where μ is a strictly positive parameter representing the frequency at which agents return their position (buy if they are on liquid position or sell if they are on a stock position). Let us give a simple graphical illustration of this model. At time 0, 3 agents are on a liquid position (left side of Fig. 3) and 3 agents on a stock position (right side of Fig. 3). Each agent is characterized by two rows in Fig. 3, the upper row represents its quantity of liquid and the lower row its quantity of stock. At time 0, $p(0) = 0$ and all the agents have the same wealth. The upper curve in Fig. 3 represents $t \rightarrow p(t)$ and since between time 0 and time 50 nobody is willing to buy or to sell and the price remains constant.

At time 51 (Fig. 4), the agent number 3 decides to buy stocks with all his liquids, since nobody is willing to sell at that time he put himself in a first in first out (FIFO) queue of buyers. Since some people are willing to buy, $p(t)$ increases linearly with a slope $\alpha > 0$.

Agent number 3 remains in the queue of buyers until time 140 (Fig. 5) and at that time the clock of the agent number 6 rings and he decides to sell his stocks,

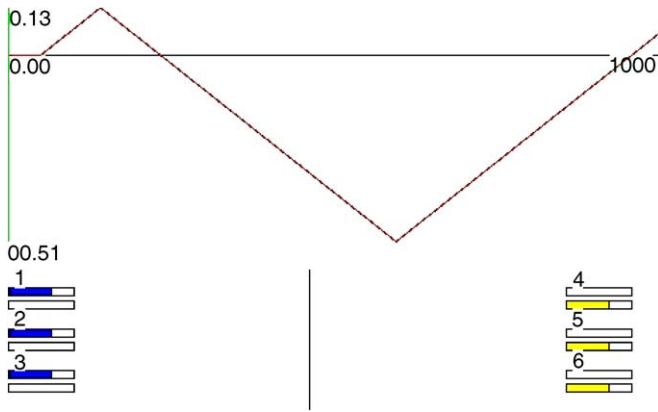

Fig. 3. At time 0.

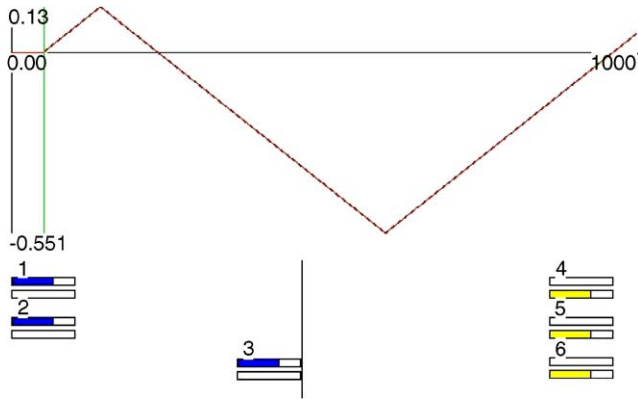

Fig. 4. At time 51.

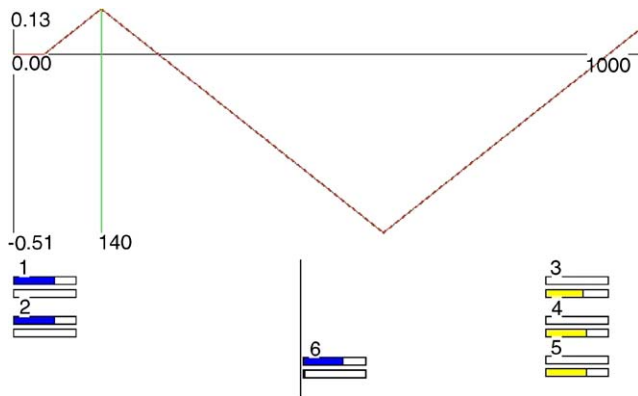

Fig. 5. At time 140.

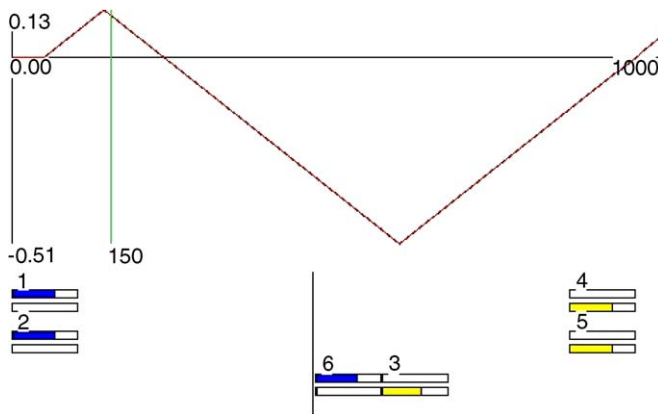

Fig. 6. At time 150.

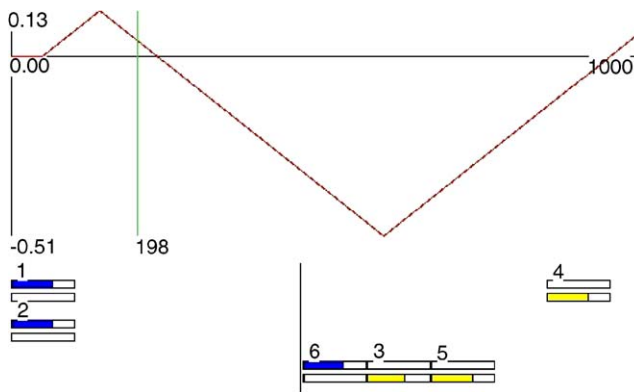

Fig. 7. At time 198.

the transaction with agent number 3 is done instantaneously at the price $\exp(p(140))$ and since the price is greater than one, agent number 3 is completely served and he can return his position while agent number 6 remains in a FIFO queue of sellers with some stocks left to be sold. After time 140, since there is a queue of sellers the price decreases linearly with slope α .

At time 150 (Fig. 6) agent number 3 decides to sell his stocks and since nobody is willing to sell at that time he put himself at the last rank in the queue of sellers.

At time 198 (Fig. 7) agent number 5 decides to sell his stocks and since nobody is willing to sell at that time he put himself at the last rank in the queue of sellers.

At time 427 (Fig. 8) agent number 1 decides to buy stocks, since there is enough stocks in the queue of sellers he can completely return his position. Agent numbers 6 and 3 are completely served and agent number 5 partially, he remains in the queue of sellers at the first rank.

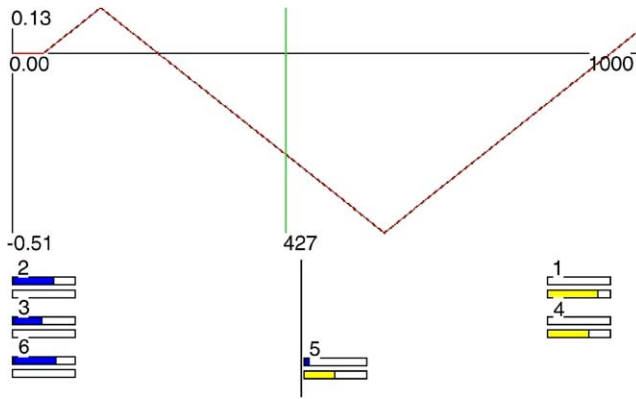

Fig. 8. At time 427.

Let us now put this model into equations.

The state space: These traders are characterized by 4 parameters. For $i \in \{1, \dots, 2N\}$,

- $Q_i^L \in \mathbb{R}^+$ represents the quantity of liquid owned by agent i .
- $Q_i^S \in \mathbb{R}^+$ represents the quantity of stock owned by agent i .
- $s_i \in \{-1, 1\}$ the position of the agent -1 for Liquid and 1 for Stock.
- $m_i \in \mathbb{N}$ the position of the agent in the queue of traders waiting to change their position. For $m_i = 0$ the agent is not in a queue of people willing to change their position.

We write $\mathcal{A} := \mathbb{R}^+ \times \mathbb{R}^+ \times \{-1, 1\} \times \mathbb{N}$ the state space of the agents. We write $\mathcal{S} := \mathcal{A}^{2N}$ the state space of the $2N$ agents, we write ζ its elements and $\zeta_i := (Q_i^L, Q_i^S, s_i, m_i)$ the state of the agent i . We write η the empirical measure associated to ζ

$$\eta := \frac{1}{2N} \sum_{i=1}^{2N} \delta_{\zeta_i} . \tag{2.1}$$

We write (Q^L, Q^S, s, m) the generic form of an element of \mathcal{A} .

2.1. Dynamic of the model

We write $\zeta(t)$ the state of the market at the time t , we characterize $\zeta(0)$ by

$$\zeta_i(0) = \left(\frac{1}{N}, 0, -1, 0 \right) \quad \text{for } 1 \leq i \leq N \tag{2.2}$$

and

$$\zeta_i(0) = \left(0, \frac{1}{N}, 1, 0 \right) \quad \text{for } N + 1 \leq i \leq 2N . \tag{2.3}$$

We write $p(t)$ the logarithm of the price of the stock at the time t . We set

$$p(0) = 0 . \tag{2.4}$$

The dynamic of the price is the following:

$$dp(t) = \alpha 2N\eta(-s1(m = 1)) . \tag{2.5}$$

So if nobody is waiting in the queue $p(t)$ remains constant, if a buyer is waiting (then $2N\eta(-s1(m = 1)) = 1$) then $p(t)$ increases linearly with a slope α , if a seller is waiting then $p(t)$ decreases linearly with a slope $-\alpha$.

For a cad lag process f we will write

$$f(t^-) := \lim_{s \uparrow t, s < t} f(s) . \tag{2.6}$$

We write

$$J_i^L(t) := \{s \in [0, t] : \zeta^i(s^-) \neq \zeta^i(s) \text{ and } \zeta^i(s^-) = (Q_i^L(s^-), 0, -1, 0)\} \tag{2.7}$$

the set of times at which the agent i take the decision to buy stocks. We write

$$J_i^S(t) := \{s \in [0, t] : \zeta^i(s^-) \neq \zeta^i(s) \text{ and } \zeta^i(s^-) = (0, Q_i^S(s^-), 1, 0)\} \tag{2.8}$$

the set of times at which the agent i decides to sell his stocks. We write $F^S(t)$ the cumulated flow of stock until the time t

$$F^S(t) := \sum_{i=1}^{2N} \sum_{s \in J_i^S(t)} Q_i^S(s^-) . \tag{2.9}$$

If $F^S(t)$ jumps at time t we will use the notation $dF^S(t) := F^S(t) - F^S(t^-)$. We write $F^L(t)$ the cumulated flow of liquid until the time t

$$F^L(t) := \sum_{i=1}^{2N} \sum_{s \in J_i^L(t)} Q_i^L(s^-) . \tag{2.10}$$

Now we write

$$Z(\eta) := \max\{m \in \mathbb{N} : \eta(m) > 0\} \tag{2.11}$$

the total number of people waiting in a queue. We write

$$W^L(\eta) := 2N\eta(Q^L 1(s = -1) 1(m \geq 1)) \tag{2.12}$$

the quantity of liquid in the transaction queue and

$$W^S(\eta) := 2N\eta(Q^S 1(s = 1) 1(m \geq 1)) \tag{2.13}$$

the quantity of Stock. We write

$$W^L(\eta, n) := 2N\eta(Q^L 1(s = 1) 1(1 \leq m \leq n)) \tag{2.14}$$

the quantity of total liquid of the first n agents waiting in the queue of buyers. We define similarly $W^S(\eta, n)$.

2.1.1. *From the point of view of the agent i*

In this paragraph we will give the dynamic of the model from the point of view of agent i assuming that he is on a Liquid position. The dynamic from the point of view of an agent on a stock position is similar.

If $s_i = -1$:

- Assume that at the time t_0 , the agent i is on a pure Liquid position $\zeta_i(t_0) = (Q_i^L(t_0), 0, -1, 0)$. Then the agent i waits random time u (independent from the state of the market and the other agents) of exponential law with parameter μ . At the time $t_1 = t_0 + u$ he decides to buy stocks

- If $W^S(t_1^-) = 0$ then nobody is willing to sell stocks and the agent i put himself in the queue of buyers at the last position: ζ_i jumps at the time t_1 to

$$\zeta_i(t_1) = (Q_i^L(t_0), 0, -1, Z(t_1^-) + 1) . \tag{2.15}$$

- If $Q_i^L(t_0) \leq W^S(t_1^-)e^{p(t_1)}$ then the quantity of stocks waiting in queue a of sellers is sufficient to allow the agent i to return his position, the transaction is completely and instantaneously realized and ζ_i jumps at the time t_1 to

$$\zeta_i(t_1) = (0, Q_i^L(t_0)e^{-p(t_1)}, -1, 0) . \tag{2.16}$$

- If $W^S(t_1^-) > 0$ and $Q_i^L(t_0) > W^S(t_1^-)e^{p(t_1)}$ then some people are willing to sell but the quantity of stocks waiting in the queue of sellers is not sufficient to allow agent i to completely return his position. The agent i is partially served by buying all the stocks in the queue of sellers and he put himself at the first position in the queue of buyers waiting to exchange his remains of liquidity into stocks. Thus ζ_i jumps at the time t_1 to

$$\zeta_i(t_1) = (Q_i^L(t_0) - W^S(t_1^-)e^{p(t_1)}, W^S(t_1^-), -1, 1) . \tag{2.17}$$

- Assume that at the time t_0 the agent i is waiting in a queue of buyers at the position $m_i(t_0)$, $\zeta_i(t_0) = (Q_i^L(t_0), 0, 1, m_i(t_0))$ with $m_i(t_0) \geq 2$. The next jump of the state of agent i does not depend on his decision but on the decision of a trader on a stock position willing to sell. Let t_1 be the first jump time of $F^S(t)$ such that $t_1 > t_0$ and write $n := \sup\{k \in \mathbb{N} : W^L(t_1^-, k) \leq e^{p(t_1)} dF^S(t_1)\}$. So at time t_1 a trader on a Stock position decides to sell and he will completely serve at most n buyers.

- If $n = 0$ then ζ_i does not jump at the time t_1 and

$$\zeta_i(t_1) = \zeta_i(t_0) . \tag{2.18}$$

- If $1 \leq n \leq m_i(t_0) - 2$ then agent i stays in the queue of buyers but changes his rank in that queue: ζ_i jumps at the time t_1 to

$$\zeta_i(t_1) = (Q_i^L(t_0), 0, 1, m_i(t_0) - n) . \tag{2.19}$$

- If $n = m_i(t_0) - 1$ then agent i is partially served by the seller and stays in the queue of buyers at the first position: ζ_i jumps at the time t_1 to

$$\begin{aligned} \zeta_i(t_1) = & : (Q_i^L(t_0) - e^{p(t_1)} dF^S(t_1), dF^S(t_1) - e^{-p(t_1)} \\ & \times W^L(t_0, m_i(t_0) - 1, 1, 1)) . \end{aligned} \tag{2.20}$$

- If $n \geq m_i(t_0)$ then agent i is completely served: ζ_i jumps at the time t_1 to

$$\zeta_i(t_1) = (0, Q_i^L(t_0)e^{-p(t_1)}, -1, 0) . \tag{2.21}$$

- Assume that at the time t_0 , agent i is waiting in the first position of the queue of buyers and that he has already bought some stocks: $\zeta_i(t_0) = (Q_i^L(t_0), Q_i^S(t_0), -1, 1)$. Let $t_1 := \inf\{x > t_0 : F^S(x^-) \neq F^S(x)\}$.

- If $e^{p(t_1)} dF^S(t_1) < Q_i^L(t_0)$ then

$$\zeta_i(t_1) = (Q_i^L(t_0) - e^{p(t_1)} dF^S(t_1), Q_i^S(t_0) + dF^S(t_1), -1, 1) .$$

- If $e^{p(t_1)} dF^S(t_1) \geq Q_i^L(t_0)$ then

$$\zeta_i(t_1) = (0, Q_i^S(t_0) + e^{-p(t_1)} Q_i^L(t_0), 1, 0) .$$

This completes the dynamic of the model from the point of view of an agent on a liquid position. The dynamic of the model from the point of view of an agent on a stock position is similar.

3. Outcome of the dynamic

In Fig. 1 we have given a simulation of the model with $2N = 1000$ agents. As we can see, $p(t)$ fluctuates around the equilibrium value 0 until the critical time t_c , at the time t_c the prices decreases exponentially towards 0 or increases exponentially towards $+\infty$. In fact it is easy to observe that t_c corresponds to a time at which all the agents are willing to buy or all the agents are willing to sell (leading to the collapse of the market). That is why we will define t_c as the minimal time when the queue of people waiting to return their position is composed of $2N$ agents (the whole population)

$$t_c := \inf\{t \in \mathbb{R}^+ : Z(t) := 2N\} \cup \{\infty\} .$$

It is then easy to prove rigorously that a.s. $t_c < \infty$. Moreover,

$$t_c = \frac{1}{\mu} X \left(N, \frac{\alpha}{\mu} \right) , \tag{3.1}$$

where $X(N, \alpha/\mu)$ is a random variable on $\mathbb{R}^{+,*}$ whose law depends only on $(N, \alpha/\mu)$.

Thus with probability one the market crashes at the random time t_c . In Fig. 9 we have given a numerical simulation of the distribution of t_c with $2N = 100$, $\alpha = 0.01$ and $\mu = 0.1$. Numerical simulations and the mechanism of the collapse suggest that as the number of agents grows large t_c concentrates around its measure: as $N \rightarrow \infty$,

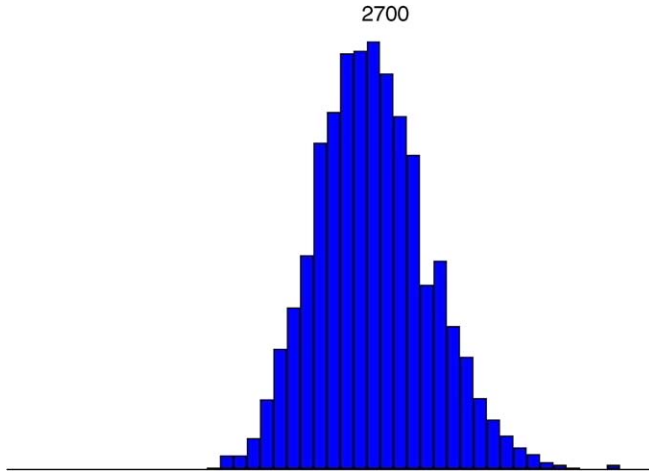

Fig. 9. Distribution of t_c .

$t_c/\mathbb{E}[t_c] \rightarrow 1$ in probability. First let us give some estimates of mean value of t_c . We will assume that the number of agents is large

$$N \gg 1 \tag{3.2}$$

and that the change in the log price during the interval of time separating the decisions of two different traders is small (we assume that the market is liquid) which corresponds to

$$\frac{\alpha}{N\mu} \ll 1. \tag{3.3}$$

Now we have the following estimates:

- For $N \gg (\mu/\alpha)^2$:

$$\mathbb{E}[t_c] \sim \frac{1}{\mu} N^{2/3} \ln(N) \left(\frac{\mu}{\alpha}\right)^{2/3} C \tag{3.4}$$

with $C = \frac{1}{2^{1/3}} \left[1 - \sqrt{\frac{1}{3}} \sqrt{1 + \frac{\ln(\mu/\alpha)}{\ln N}} \right]^2$.

- For $(\frac{\mu}{\alpha})^{1/2} \ll N \ll (\mu/\alpha)^2$:

$$\mathbb{E}[t_c] \sim \frac{1}{\mu} \ln(N) \left(\frac{\mu}{\alpha}\right)^2 C \tag{3.5}$$

with $C = \left[1 - \sqrt{\frac{1}{3}} \sqrt{1 + \frac{\ln(\mu/\alpha)}{\ln N}} \right]^2$.

- For $N \ll (\mu/\alpha)^{1/2}$:

$$\mathbb{E}[t_c] \sim \frac{1}{\mu} \frac{N^{4/3}}{\ln(N)} \left(\frac{\mu}{\alpha}\right)^{4/3} C \tag{3.6}$$

with $C = \frac{1}{2^{2/3}}$.

We refer to the next section for the details on the derivation of Eqs. (3.4)–(3.6). More precisely these equations correspond to different asymptotic (N compared to μ/α) of Eq. (4.15).

4. Mechanism

Let us now give the origin of the collapse. Write $W_i := Q_i^L + e^p Q_i^S$ the wealth of the agent i . We will now look at the distribution of the logarithm of the wealth of the agents, more precisely at

$$M := \frac{1}{2N} \sum_{i=1}^{2N} \delta_{\ln(Q_i^L + e^p Q_i^S)}.$$

We have illustrated this distribution at different times in Figs. 10–16. As one can see, for a fixed time the distribution of wealth is Log Normal. As time passes the Log Wealth distribution widen due to propagation of chaos in the individual wealth of agents and the center of mass is shifted to the left (so on the long run only a few agents make money in such a market, this feature also characterizes Minority Games [6]). The point is that the log wealth distribution goes to the extremes without any limit and at some point an agent will hold more than half of the wealth in the market and at that point the market will collapse if he tries to return his position.



Fig. 10. At time 0.

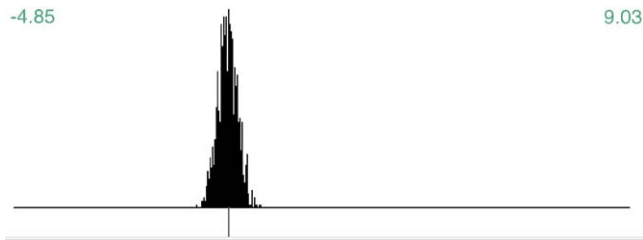

Fig. 11. At time 300.

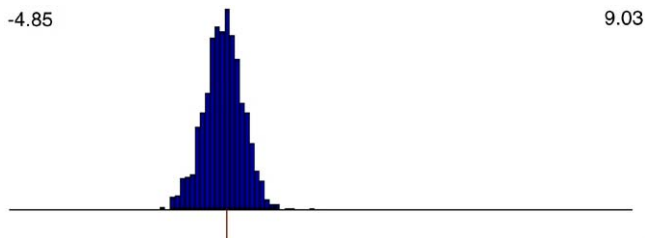

Fig. 12. At time 1000.

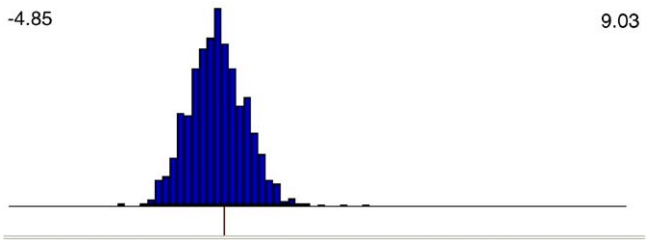

Fig. 13. At time 2000.

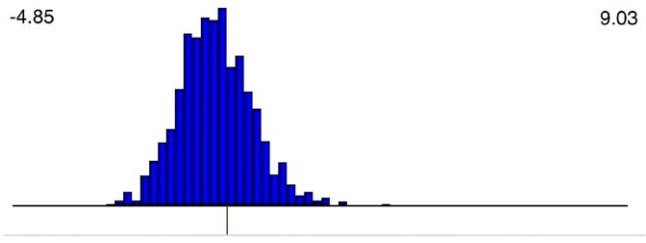

Fig. 14. At time 3000.

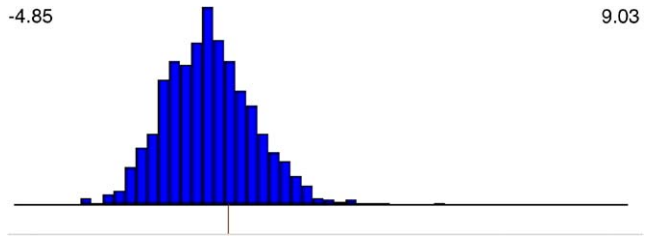

Fig. 15. At time 4000.

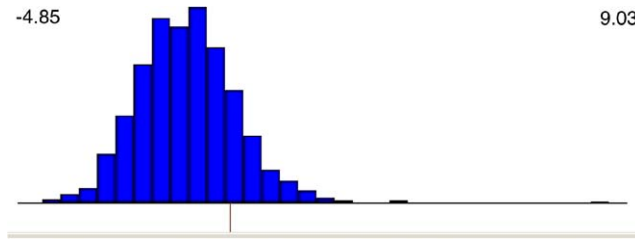

Fig. 16. At time 4630 just before the crash.

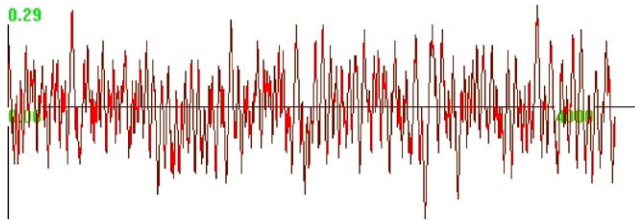

Fig. 17. Price fluctuations.

4.1. Price fluctuation

First we have to understand why before the crash the price fluctuates around an equilibrium (Fig. 17). First observe that there is no destruction or creation of Liquid or Stock in our market. Thus, these are conserved quantities: $\forall t, \eta(t, Q^L) = 1$ and $\eta(t, Q^S) = 1$. Now observe that as $dt \downarrow 0$,

$$\mathbb{E} \left[\frac{F^L(t + dt) - F^L(t)}{dt} \right] \rightarrow \eta(t, Q^L 1(s = -1, m = 0)) \tag{4.1}$$

and

$$\mathbb{E} \left[\frac{F^S(t + dt) - F^S(t)}{dt} \right] \rightarrow \eta(t, Q^S 1(s = 1, m = 0)) \tag{4.2}$$

thus the expectation of the flow of Liquid in our market per unit time is the quantity of liquid in the market held by traders who are not waiting to return their positions. Similarly the flow of Stock in our market per unit time is the quantity of Stock in the market hold by traders who are not waiting to return their positions.

Now let us consider a given small interval of time Δt , let us consider a time when the quantity of liquid or stocks waiting in a queue is small, then flow of liquid is of the order of $\mu \Delta t$ whereas the flow of stock (converted in a flow of liquid at the price e^p) is of the order of $e^p \mu \Delta t$. Thus if $p > 0$ a queue of sellers is created and the price decrease (the queue of sellers by an entropic effect also decreases the flow of stock pushing the market towards equilibrium); if $p < 0$ then a queue of buyers is created and the price increases towards 0. This explains why 0 is an equilibrium value for p

before the collapse, now let us estimate the size of the fluctuations Δp of p around that value. Assume that at time t the value of p is Δp , and assume that after that time p reaches the value $2 \Delta p$. In order to reach that value p must stay above Δp during a interval of time of (at least) $\Delta p/\alpha$. During that time the size of the fluctuation of the flow of Liquid is of the order of $\sqrt{\mu \Delta t/N}$. The fluctuations of p are created by the fluctuations of the flow Liquid and Stock and Δp is given by the following equation

$$\mu \Delta t + \sqrt{\frac{\mu \Delta t}{N}} \sim e^{\Delta p} \mu \Delta t . \tag{4.3}$$

This leads to

$$\frac{\alpha}{N\mu} \sim \Delta p (e^{\Delta p} - 1)^2 . \tag{4.4}$$

We deduce that for $N \gg \alpha/\mu$,

$$\Delta p \sim \left(\frac{\alpha}{N\mu} \right)^{1/3} \tag{4.5}$$

which is confirmed by numerical simulations.

4.2. Wealth distribution

Write W_i the wealth of agent i given by the following formula:

$$W_i := Q_i^L + e^p Q_i^S . \tag{4.6}$$

In Figs. 18–20 we have simulated the wealth of three different agents.

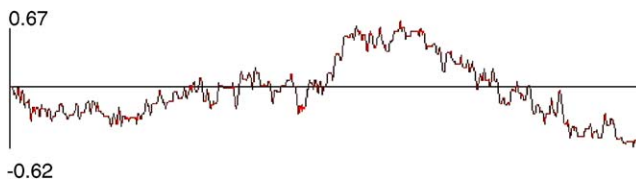

Fig. 18. Wealth of agent 303.

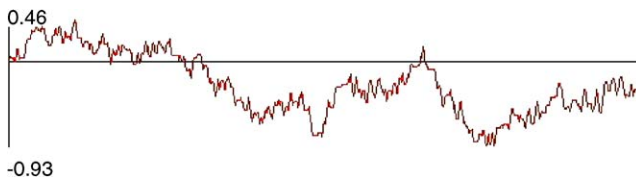

Fig. 19. Wealth of agent 125.

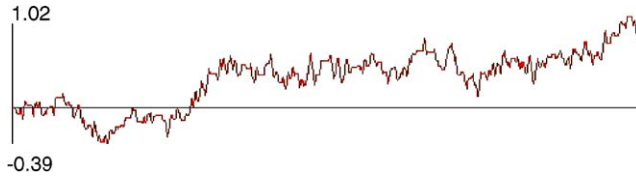

Fig. 20. Wealth of agent 187.

Write Δq the size of the fluctuations of $\ln W_i$ between two transaction times. Observe that it is also the size of the fluctuation of p between two transaction times. Write $\Delta\tau$ the interval of time separation two changes of position of the agent i . If the time agent i spent in a queue is small compared to that time then it is easy to check that

$$\langle \Delta\tau \rangle \sim \frac{1}{\mu} \tag{4.7}$$

and

$$\langle (\Delta\tau)^2 \rangle \sim \frac{2}{\mu^2} . \tag{4.8}$$

Now $p(t)$ is strongly self-correlated for short times, in other words for $\Delta\tau \ll \Delta p/\alpha$ we have $\langle \Delta q \rangle \sim \Delta\tau\alpha$ and

$$\langle \Delta q \rangle \sim \frac{\alpha}{\mu} \tag{4.9}$$

similarly

$$\langle (\Delta q)^2 \rangle \sim 2 \frac{\alpha^2}{\mu^2} . \tag{4.10}$$

However for $\Delta\tau \gg \Delta p/\alpha$, Δq is of the order of the size of the fluctuations of p and we have

$$\langle \Delta q \rangle \sim \Delta p . \tag{4.11}$$

Now “in principle” $\ln W_i(t)$ should behave like a continuous random walk which can be approximated by writing

$$\ln W_i(t) \sim \Delta q B_{t\mu}^i , \tag{4.12}$$

where the B^i are independent Brownian Motions. But we have the constraint

$$\sum_{i=1}^{2N} e^{\ln W_i} = 1 + e^p \sim 2 \tag{4.13}$$

due to the conservation of the total quantity of Stock and Liquid in the market. In conclusion we have obtained that the $\ln W_i$ should behave like $2N$ i.i.d Brownian Motions conditioned by relation (4.13) which leads to

$$\ln W_i(t) \sim \sigma^{1/2} B_1^i - \frac{\sigma}{2} \tag{4.14}$$

with $\sigma = \langle (\Delta q)^2 \rangle^{1/2} \sqrt{\mu \bar{u}}$. Now writing

$$\phi(x) := \frac{1}{\sqrt{2\pi}} \int_x^\infty e^{-z^2/2} dz$$

the wealth of the richest fraction y of the population is

$$W(y) \sim 2\phi(\phi^{-1}(y) - \sigma^{1/2}).$$

Thus the wealth of the richest agent of the order of $W(1/2N)$. Now one may think that the collapse occurs when $W(1/2N)$ is of the order of one (when the richest agent owns half of the wealth in the market). Actually this is not what is really happening, at some point the market becomes biased in favor of the richest agent although this cannot be seen from the behavior of the price. This can be seen on Figs. 13–16 (the logarithm wealth of the richest agent increases ballistically).

4.3. Biased market

Assume that at time t , the agent i is on a pure stock position ($\zeta_i = (0, Q_i^S, 1, 0)$) and he decides to freeze his position. This decision will shift the equilibrium log price from 0 to a new value that we will write $p_e(Q_i^S)$. It is easy to obtain from the flow of liquid and the flow of stock that $p_e(Q_i^S)$ is given by the following relation:

$$1 = e^{p_e}(1 - Q_i^S)$$

which leads to (for $Q_i^S \ll 1$)

$$p_e(Q_i^S) \sim Q_i^S.$$

We deduce that for $Q_i^S \ll \Delta p$ the influence of agent i decision is not significant. However if $Q_i^S \gg \Delta p$ the influence of agent i decision is significant. Thus if $W_i - 1/N \ll \Delta p$, the market has no bias in favor of agent i . If $W_i - 1/N \geq \Delta p$ the market is biased in favor of agent i , and the growth of $\ln W_i$ becomes ballistic. Write $Q_c := 2(\alpha/N\mu)^{1/3}$. The dynamic of the wealth distribution changes as soon as $W(1/2N) \sim 1/N + Q_c$. In resume (after tracking all the constants)

$$\begin{aligned} \langle t_c \rangle \sim & \frac{1}{\mu \langle (\Delta q)^2 \rangle} \left(\phi^{-1} \left(\frac{1}{4N} \right) - \phi^{-1} \left(\frac{1}{4N} + \left(\frac{\alpha}{N\mu} \right)^{1/3} \right) \right)^2 \\ & - \frac{4}{\mu \langle \Delta q \rangle} \ln \left(\frac{1}{2N} + 2 \left(\frac{\alpha}{N\mu} \right)^{1/3} \right) \end{aligned} \tag{4.15}$$

which is confirmed by numerical simulations. Now (in the liquid market regime, i.e., $N \gg \alpha/\mu$) from Eqs. (4.5), (4.9)–(4.11) we obtain that

- For $N \gg (\mu/\alpha)^2$

$$\langle \Delta q \rangle \sim \left(\frac{\alpha}{N\mu} \right)^{1/3}. \tag{4.16}$$

- For $N \ll (\mu/\alpha)^2$:

$$\langle \Delta q \rangle \sim \frac{\alpha}{\mu}. \tag{4.17}$$

Combining these estimates with (for $x \ll 1$)

$$\phi^{-1}(x) \sim \sqrt{-2 \ln x}$$

we obtain estimates (3.4)–(3.6). The regime $N \ll (\mu/\alpha)^{1/2}$ corresponding to the condition

$$\frac{1}{4N} \gg \left(\frac{\alpha}{N\mu} \right)^{1/3} \tag{4.18}$$

in (4.15).

4.4. The Pareto parameter

Write $y_p(\eta)$ the Pareto parameter of the market defined by the fact that the fraction $y_p(\eta)$ of the richest agents own a fraction $1 - y_p(\eta)$ of the total wealth in the market with respect to the equilibrium price. Let us write t_b the time at which the market becomes biased (minimal time such that $W(1/2N) \geq 1/2N + Q_c$). It is easy to obtain that

$$y(t_b) = \phi \left(\frac{1}{2} \left(\phi^{-1} \left(\frac{1}{2N} \right) - \phi^{-1} \left(\frac{1}{2} \left(\frac{\alpha}{N\mu} \right)^{1/3} \right) \right) \right) \tag{4.19}$$

from which we deduces that for $N \gg 1$, $N \gg (\mu/\alpha)^2$

$$y_p(t_b) \sim CN^{-v}$$

with $C = (1/2)^{1/8}$ and $v = \frac{1}{8} \left(1 - \sqrt{\frac{1}{3} + \frac{1}{3} \frac{\ln(\mu/\alpha)}{\ln N}} \right)$.

It is interesting to observe that for a very large number of agents this critical Pareto parameter depends only on N and not on α or μ . In other words for a large population of traders there exists a critical value for the Pareto parameter depending on the size of the population below which the market “run” towards collapse.

4.5. Economical shocks and cycles

4.5.1. Numerical applications

Let us now give a few numerical estimates of the time of collapse. In practice we know $2N$ the number of traders, μ the frequency at which they change their position but α is an endogenous parameter. This is not a problem since in practice we know $\langle \Delta q \rangle$, the typical benefit or loss of a trader over the period $1/\mu$ and we can deduce α from Δq .

- Now with $2N = 1000$, $\mu = 1/\text{month}$ and $\Delta q = 0.04$ we find that $t_c \sim 40$ years and $y_p(t_b) \sim 0.21$.
- With $2N = 1\,000\,000$, $\mu = 1/\text{day}$ and $\Delta q = 0.01$ we find that $t_c \sim 48$ years and $y_p(t_b) \sim 0.09$.

4.5.2. What about the sensitivity of t_c ?

The first natural question is what happens if we slightly modify N , μ or Δq (will we obtain 50 000 years instead of 50?). Eq. (3.4) shows that the dependence of t_c on the leading factors has the following form:

$$\langle t_c \rangle \sim C \frac{\ln N}{\mu(\Delta q)^2}. \quad (4.20)$$

Thus by changing $2N$ from 1000 to 1 000 000, $\langle t_c \rangle$ is only multiplied by two. By changing Δq from 0.04 to 0.02, $\langle t_c \rangle$ is multiplied by 4. By changing μ from once a month once every 2 months, $\langle t_c \rangle$ is multiplied by two. More precisely using formula (4.15) with $2N = 1\,000\,000$, $\mu = 0.5/\text{month}$ and $\Delta q = 0.02$ we obtain that $\langle t_c \rangle \sim 278$ years.

4.5.3. What about the limitations of our model?

The model presented in this paper is very simple in the sense that in real markets there is some interaction between agents, traders are reacting to fundamentals and news, moreover they have different time horizons usually described as scalpers ($1/\mu$ is of the order of 1 min), day-traders ($1/\mu \sim 1$ h), swing traders ($1/\mu \sim 1$ week to 1 month), investors ($1/\mu \sim 1$ month to 1 year), long-term investors or family type investors ($1/\mu \sim 5$ years). However even with these sophistication the market remains a random environment where at each transaction half of the traders are on the losing side of the market. This randomness must lead to the propagation of chaos in the wealth distribution of the agents leading to a multi scaled shocks: it is interesting in that context to observe that power-law distributions in market fluctuations can be explained from the individual decisions of large traders [7].

4.5.4. Economical shock

Now there are two point of views, the point view described in the paper of Mézard and Bouchaud [8] is that the economy reaches a stationary state with a constant Pareto wealth distribution. To obtain that stationary state they had to assume that the number of traders is infinite and that each trader gives a fixed portion of his wealth uniformly to the other traders. We believe with our model that this Pareto distribution is not constant and it spreads to the extremes due to the propagation of Chaos among the wealth of the traders in the market. Observe that Eq. (4.15) is not specific to our model in the sense that it reflects this propagation of chaos. Now in a real market as one knows the quantity of liquids (and stocks) are not constant, this introduces a drift in the dynamic of $p(t)$ but observe that it does not influence the way the distribution of wealth spreads since for instance the dividends earned by a trader on a stock position is proportional to the quantity of wealth that he owns. It is obvious that the market cannot sustain this propagation of chaos in the wealth distribution forever and at some point an “economic shock” must occur. If this is true then one must have some traces of those economical shocks in history. Actually these shocks are present in the form of cycles divided into a period Inflationary growth, a period of Stagflation, a period of Deflationary Growth and a period of Depression (shock). It was noted in 1847 in an article in the *British Railway Journal* by Dr. Hyde Clark that economies are characterized by a 50–60 year

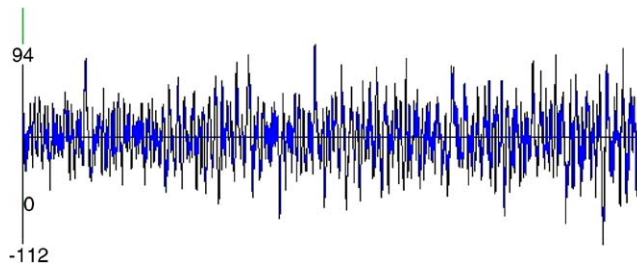

Fig. 21. Number of agents in the queue.

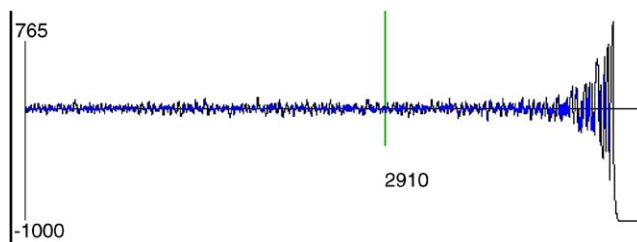

Fig. 22. Number of agents in the queue.

cycle in prices, interest rates and other variables. It was N.D. Kondratiev who first described the cycle in detail and for whom the cycle is named.

4.6. A precursor of the collapse ?

We would like to address in this subsection a last point: is there a precursor before the market collapse? First as one can see it is not obvious at all to deduce from the behavior of the price when the market is going to collapse. Next, if one knows the wealth distribution one can have some estimates about the delay before collapse but let us assume that this wealth distribution is hidden. Now let us observe the number of people waiting to return their position, as one can see on Figs. 21 and 22 (the number is positive if the people in the queue are buyers and negative if they are sellers), this number has small fluctuations around 0 (Fig. 21) but just before the crash (Fig. 22) the dynamic of the queue becomes viscous (not visible on the price dynamic) and its size bursts giving us a precursor of the collapse.

Acknowledgements

The author would like to thank Gérard Ben Arous for a stimulating discussion on the Kondratiev cycle.

References

- [1] D. Sornette, Critical market crashes, arXiv:cond-mat/0301543, 2003.
- [2] J.-P. Bouchaud, R. Cont, A Langevin approach to stock market fluctuations and crashes, *Eur. Phys. J. B* 6 (4) (1998) 543–550.
- [3] G. Caldarelli, M. Marsili, Y.-C. Zhang, A prototype model of stock exchange, *Europhys. Lett.* 40 (5) (1997) 479–484.
- [4] P. Bak, M. Paczuski, M. Shubik, Price variations in a stock market with many agents, *Phys. A* 246 (1997) 430–453.
- [5] I. Giardina, J.-P. Bouchaud, Bubbles, crashes and intermittency in agent based market models, cond-mat/0206222, 2002.
- [6] D. Challet, Yi-Cheng Zhang, Emergence of cooperation and organization in an evolutionary game, *Phys. A* 246 (1997) 407–418.
- [7] X. Gabaix, P. Gopikrishnan, V. Plerou, H.E. Stanley, A theory of power-law distributions in financial market fluctuations, *Nature* 423 (2003) 267–270.
- [8] J.-P. Bouchaud, M. Mézard, Wealth condensation in a simple model of economy, *Phys. A* 282 (2000) 536–545.